

# SUNSAVER MPPT™

WITH TRAKSTAR™ MPPT TECHNOLOGY

## Installation, Operation and Maintenance Manual

For the most recent manual revisions, see the  
version at: [www.morningstarcorp.com](http://www.morningstarcorp.com)



SS-MPPT-15L



MORNINGSTAR

World's Leading Solar Controllers & Inverters

[www.morningstarcorp.com](http://www.morningstarcorp.com)

## SunSaver MPPT Dimensions

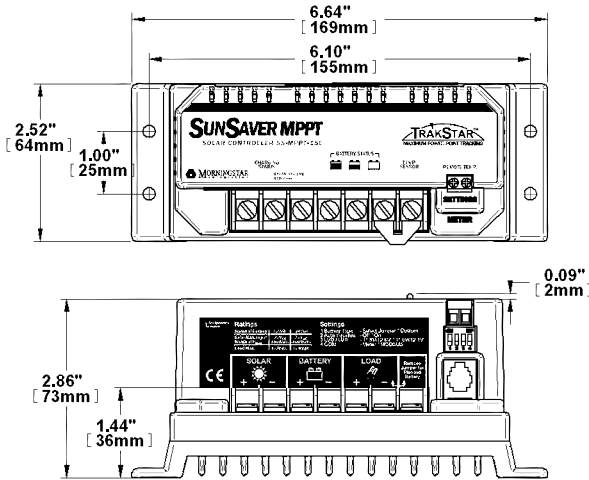

## Specification Summary

System Voltage	12 / 24 Volts
Rated Battery Current	15 Amps
Rated Load Current	15 Amps
Maximum Input Voltage*	60 Volts
Nominal Maximum Input Power**	
12 Volt System	200 Watts
24 Volt System	400 Watts

See Section 7.0 for full technical specifications

\* Array Voltage should never exceed maximum input voltage. Refer to the solar module documentation to determine the highest expected array  $V_{oc}$  as defined by the lowest expected ambient temperature for the system location.

\*\* These power levels refer to the maximum wattage the SS-MPPT-15L can process at a certain system voltage. Higher power arrays can be used without damaging the controller.

## Contents

1.0 Important Safety Instructions	4
2.0 General Information	15
2.1 Overview	15
2.2 Features	16
2.3 Optional Accessories	18
2.4 Regulatory Information	20
3.0 Installation Instructions	22
3.1 General Installation Notes	22
3.2 Configuration	24
3.3 Mounting	27
3.4 Wiring	29
4.0 Operation	37
4.1 LED Indications	37
4.2 TrakStar™ MPPT Technology	39
4.3 Battery Charging	42
4.4 Load Control Information	44
4.5 Protections	46
4.6 Inspection and Maintenance	49
4.7 Programming Custom Set-points	51
4.8 Data-logging	52
5.0 Troubleshooting	53
5.1 Error Indications	54
5.2 Common Problems	55
6.0 Warranty and Policies	56
7.0 Technical Specifications	60
Appendix - Wire Sizing Charts	65
Certifications	67

## 1.0 Important Safety Instructions

### SAVE THESE INSTRUCTIONS.

This manual contains important safety, installation, operating and maintenance instructions for the SunSaver-MPPT solar controller.

The following symbols are used throughout this manual to indicate potentially dangerous conditions or mark important safety instructions:

 **WARNING:** *Indicates a potentially dangerous condition. Use extreme caution when performing this task.*

 **CAUTION:** *Indicates a critical procedure for safe and proper operation of the controller.*

 **NOTE:** *Indicates a procedure or function that is important to the safe and proper operation of the controller.*

### CONSIGNES IMPORTANTES DE SÉCURITÉ CONSERVEZ CES INSTRUCTIONS.

Ce manuel contient des instructions importantes de sécurité, d'installations et d'utilisation du contrôleur solaire.

SunSaver-MPPT. Les symboles suivants sont utilisés dans ce manuel pour indiquer des conditions potentiellement dangereuses ou des consignes importantes de sécurité.

 **AVERTISSEMENT:** *Indique une condition potentiellement dangereuse. Faites preuve d'une prudence extrême lors de la réalisation de cette tâche.*

 **PRUDENCE:** *Indique une procédure critique pour l'utilisation sûre et correcte du contrôleur.*

 **REMARQUE:** *Indique une procédure ou fonction importante pour l'utilisation sûre et correcte du contrôleur.*

### Safety Information

- Read all of the instructions and cautions in the manual before beginning installation.
- There are no user serviceable parts inside the SunSaver-MPPT. Do not disassemble or attempt to repair the controller.

 **WARNING:** *RISK OF ELECTRICAL SHOCK. NO POWER OR ACCESSORY TERMINALS ARE ELECTRICALLY ISOLATED FROM DC INPUT, AND MAY BE ENERGIZED WITH HAZARDOUS SOLAR VOLTAGE. UNDER CERTAIN FAULT CONDITIONS, BATTERY COULD BECOME OVERCHARGED. TEST BETWEEN ALL TERMINALS AND GROUND BEFORE TOUCHING.*

- External solar and battery disconnects are required.
- Disconnect all sources of power to the controller before installing or adjusting the SunSaver-MPPT.
- There are no fuses or disconnects inside the SunSaver-MPPT. Do not attempt to repair.

## Informations de Sécurité

- Lisez toutes les instructions et les avertissements figurant dans le manuel avant de commencer l'installation.
- Le SunSaver-MPPT ne contient aucune pièce réparable par l'utilisateur. Ne démontez pas ni ne tentez de réparer le contrôleur.



**AVERTISSEMENT: RISQUE DE CHOC ÉLECTRIQUE. NON ALIMENTATION OU AUX BORNES D'ACCESSOIRES SONT ISOLÉS ÉLECTRIQUEMENT DE L'ENTRÉE DE C.C ET DOIT ÊTRE ALIMENTÉS À UNE TENSION DANGEREUSE SOLAIRE. SOUS CERTAINES CONDITIONS DE DÉFAILLANCE, LA BATTERIE POURRAIT DEVENIR TROP CHARGÉE. TEST ENTRE TOUTES LES BORNES ET LA MASSE AVANT DE TOUCHER.**

- External solaire et la batterie se déconnecte sont nécessaires.
- Déconnectez toutes les sources d'alimentation du contrôleur avant d'installer ou de régler le SunSaver-MPPT.
- Le TriStar MPPT ne contient aucun fusible ou interrupteur. Ne tentez pas de réparer.
- Installez des fusibles/ coupe-circuits externes selon le besoin.

## Installation Safety Precautions



**WARNING:** *This unit is not provided with a GFDI device. This charge controller must be used with an external GFDI device as required by Article 690 of the National Electrical Code for the installation location.*

- Mount the SunSaver-MPPT indoors. Prevent exposure to the elements and do not allow water to enter the controller.
- Install the SunSaver-MPPT in a location that prevents casual contact. The SunSaver-MPPT heatsink can become very hot during operation.
- Use insulated tools when working with batteries.
- Avoid wearing jewelry during installation.
- The battery bank must be comprised of batteries of same type, make, and age.
- UL/IEC 62109 certified for use in negative ground or floating systems only
- Do not smoke near the battery bank.
- Power connections must remain tight to avoid excessive heating from a loose connection.
- Use properly sized conductors and circuit interrupters.
- The grounding terminal is located in the wiring compartment and is identified by the symbol below:



Ground Symbol

- This charge controller is to be connected to DC circuits only. These DC connections are identified by the symbol below:



Direct Current Symbol

The SunSaver-MPPT controller must be installed by a qualified technician in accordance with the electrical regulations of the country where the product is installed. A means of disconnecting all power supply poles must be provided. These disconnects must be incorporated in the fixed wiring.

A permanent, reliable earth ground must be established with connection to the SunSaver-MPPT wiring compartment ground terminal.

The grounding conductor must be secured against any accidental detachment. The knock-outs in the SunSaver-MPPT wiring compartment must protect wires with conduit or rubber rings.

### Précautions de Sécurité D'installation

 **AVERTISSEMENT:** *L'appareil n'est pas fourni avec un dispositif GFDI. Ce contrôleur de charge doit être utilisé avec un dispositif GFDI externe tel que requis par l'Article 690 du Code électrique national de l'emplacement de l'installation.*

- Montez le SunSaver-MPPT à l'intérieur. Empêchez l'exposition aux éléments et la pénétration d'eau dans le contrôleur.
- Installez le MPPT ProStar dans un endroit qui empêche le contact occasionnel. Le dissipateur de chaleur SunSaver-MPPT peut devenir très chaud pendant le fonctionnement.

- Utilisez des outils isolés pour travailler avec les batteries.
- Évitez le port de bijoux pendant l'installation.
- Le groupe de batteries doit être constitué de batteries du même type, fabricant et âge.
- UL/IEC 62109 certifié pour utilisation au négatif à la masse ou les systèmes flottants seulement.
- Ne fumez pas à proximité du groupe de batteries.
- Les connexions d'alimentation doivent rester serrées pour éviter une surchauffe excessive d'une connexion desserrée.
- Utilisez des conducteurs et des coupe-circuits de dimensions adaptées.
- La borne de mise à la terre se trouve dans le compartiment de câblage et est identifiée par le symbole ci-dessous estampillé dans le boî:



- Ce contrôleur de charge ne doit être connecté qu'à des circuits en courant continu. Ces connexions CC sont identifiées par le symbole ci-dessous:



Le contrôleur SunSaver-MPPT doit être installé par un technicien qualifié conformément aux réglementations électriques du pays où est installé le produit.

Un moyen d'assurer la déconnexion de tous les pôles de l'alimentation doit être fourni. Cette déconnexion doit être incorporée dans le câblage fixe.

À l'aide de la borne de mise à la masse du SunSaver-MPPT (dans le compartiment de câblage), un moyen permanent et fiable de mise à la terre doit être fourni. La fixation de la mise à la terre doit être fixée contre tout desserrage accidentel. Les ouvertures d'entrée au compartiment de câblage du doivent être protégées avec conduit ou anneaux.

## Battery Safety



**WARNING:** A battery can present a risk of electrical shock or burn from large amounts of short-circuit current, fire, or explosion from vented gases. Observe proper precautions.



**AVERTISSEMENT:** Une batterie peut présenter a risque de choc électrique ou de brûlure de grandes quantités de court-circuit curlouer, incendie ou explosion de ventilé gaz. Observer précautions appropriées.



**WARNING: Risk of Explosion.** Proper disposal of batteries is required. Do not dispose of batteries in fire. Refer to local regulations or codes for requirements.



**AVERTISSEMENT: Risque d'Explosion.** Au rebut des piles est nécessaire. Ne pas jeter les piles dans le feu. Se référer aux réglementations locales ou des codes pour les exigences.



**CAUTION:** When replacing batteries, use properly specified number, sizes, types, and ratings based on application and system design.



**PRUDENCE:** Lorsque le remplacement des piles, utilisez correctement nombre spécifié, tailles, types et les évaluations basées sur conception de système et d'application.



**CAUTION:** Do not open or mutilate batteries. Released electrolyte is harmful to skin, and may be toxic.



**PRUDENCE:** Ne pas ouvrir ou mutiler les piles. L'électrolyte est nocif pour la peau et peut être toxique.

- Servicing of batteries should be performed, or supervised, by personnel knowledgeable about batteries, and the proper safety precautions.
- Be very careful when working with large lead-acid batteries. Wear eye protection and have fresh water available in case there is contact with the battery acid.
- Remove watches, rings, jewelry and other metal objects before working with batteries.
- Wear rubber gloves and boots
- Use tools with insulated handles and avoid placing tools or metal objects on top of batteries.
- Disconnect charging source prior to connecting or disconnecting battery terminals.
- Determine if battery is inadvertently grounded. If so, remove the source of contact with ground. Contact with any part of a grounded battery can result in electrical

shock. The likelihood of such a shock can be reduced if battery grounds are removed during installation and maintenance (applicable to equipment and remote battery supplies not having a grounded supply circuit).

- Carefully read the battery manufacturer's instructions before installing / connecting to, or removing batteries from, the SunSaver-MPPT.
- Be very careful not to short circuit the cables connected to the battery.
- Have someone nearby to assist in case of an accident.
- Explosive battery gases can be present during charging. Be certain there is enough ventilation to release the gases.
- Never smoke in the battery area.
- If battery acid comes into contact with the skin, wash with soap and water. If the acid contacts the eye, flood with fresh water and get medical attention.
- Be sure the battery electrolyte level is correct before starting charging. Do not attempt to charge a frozen battery.
- Recycle the battery when it is replaced.
- Entretien des batteries devrait être effectué ou supervisé, par un personnel bien informé sur les piles et les précautions de sécurité appropriées.
- Soyez très prudent quand vous travaillez avec des grandes batteries au plomb. Portez des lunettes de protection et ayez de l'eau fraîche à disposition en cas de contact avec l'électrolyte.
- Enlevez les montres, bagues, bijoux et autres objets métalliques avant de travailler avec des piles.
- Porter des bottes et des gants de caoutchouc
- Utiliser des outils avec poignées isolantes et évitez de placer des outils ou des objets métalliques sur le dessus de batteries.

- Débrancher la source de charge avant de brancher ou disreliant les bornes de la batterie.
- Utilisez des outils isolés et évitez de placer des objets métalliques dans la zone de travail.
- Déterminer si batterie repose par inadvertance. Dans l'affirmative, supprimer la source du contact avec le sol. Contact avec n'importe quelle partie d'une batterie mise à la terre peut entraîner un choc électrique. La probabilité d'un tel choc peut être réduite si des motifs de batterie sont supprimés pendant l'installation et maintentretien (applicable à l'équipement et les fournitures de pile de la télécommande n'ayant ne pas un circuit d'alimentation mise à la terre).
- Lisez attentivement les instructions du fabricant de la batterie avant d'installer / connexion à ou retrait des batteries du SunSaver-MPPT.
- Veillez à ne pas court-circuiter les câbles connectés à la batterie.
- Ayez une personne à proximité qui puisse aider en cas d'accident.
- Des gaz explosifs de batterie peuvent être présents pendant la charge. Assurez-vous qu'une ventilation suffisante évacue les gaz.
- Ne fumez jamais dans la zone des batteries

- En cas de contact de l'électrolyte avec la peau, lavez avec du savon et de l'eau. En cas de contact de l'électrolyte avec les yeux, rincez abondamment avec de l'eau fraîche et consultez un médecin.
- Assurez-vous que le niveau d'électrolyte de la batterie est correct avant de commencer la charge. Ne tentez pas de charger une batterie gelée.
- Recyclez la batterie quand elle est remplacée.

### 2.1 Overview

Thank you for selecting the SunSaver MPPT charge controller with *TrakStar Technology*<sup>™</sup>. The SunSaver-MPPT (SS-MPPT) is an advanced *Maximum Power Point Tracking* solar battery charger and load controller for stand-alone PV systems. The controller features a smart tracking algorithm that maximizes the energy from the solar module(s) and also provides load control to prevent over-discharge of the battery.

The SS-MPPT battery charging process has been optimized for long battery life and improved system performance. Self-diagnostics and electronic error protection prevent damage when installation mistakes or system faults occur. The controller also features four (4) settings switches for adjustability, a meter port, and terminals for remote battery temperature measurement (optional).

Using MSView<sup>™</sup> PC software, the SS-MPPT can be programmed with custom settings to function as a lighting controller to turn the system loads on and off at specified intervals throughout the day and night. See Section 4.7 for more information.

Although the SS-MPPT is very simple to configure and use, please take the time to read this operator's manual and become familiar with the controller. This will help you make full use of the many advantages the SS-MPPT can provide for your PV system.



## 2.2 Features

The features of the SunSaver MPPT are shown in Figure 1 below. An explanation of each feature is provided.

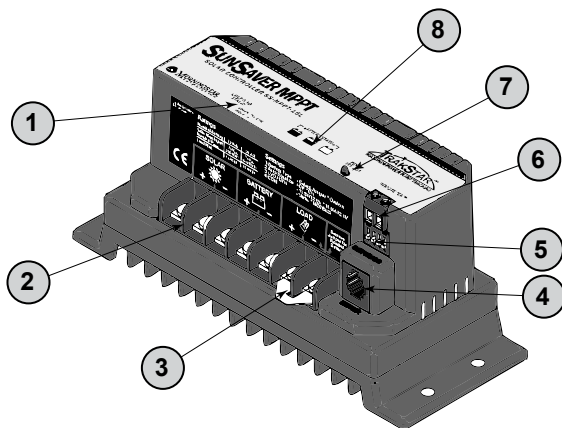

Figure 1. SunSaver MPPT features.

### 1 - Status LED

An LED indicator that shows charging status and also indicates when a solar input fault condition exists.

### 2 - Power Terminal Block

Power terminations for system Solar, Battery, and Load connections.

### 3 - Battery Select Jumper

A removable jumper to select the battery type.

### 4 - Meter Connection

A communication port for the Morningstar *Remote Meter* or personal computer (PC) connection. A *MSC* or *UMC-1* adapter is required, available separately.

### 5 - Settings Switches

Adjustment switches that define the operating parameters of the SunSaver MPPT.

### 6 - Remote Temperature Sensor (RTS) Terminals

Connection point for a Morningstar RTS (optional) to remotely monitor battery temperature.



**NOTE:** The use of a Remote Temperature Sensor is ***strongly recommended***. Controller location, air flow, and system power can drastically affect the local temperature sensor reading. A RTS will provide optimal charging performance.

### 7 - Local Temperature Sensor

Measures ambient temperature. Battery regulation is adjusted based on ambient temperature unless the optional RTS is installed.

### 8 - Battery Status LEDs

Provides approximate battery *state of charge* indication and also indicates when a system or load fault condition exists.

## 2.3 Optional Accessories

The following accessories are available for purchase separately from your authorized Morningstar dealer.

### Remote Temperature Sensor (Model: RTS)

The RTS measures battery temperature for accurate temperature compensation and is recommended when the ambient battery temperature differs from the ambient controller temperature by +/- 5 degrees C or more. An RTS can be attached to the SunSaver MPPT at any time. The SunSaver MPPT will automatically use the RTS for battery temperature compensation when installed. The standard cable length is 33 ft (10 m), and can be extended to 100 ft (30 m) if required. Installation instructions are provided with the RTS.



**NOTE:** *The use of a Remote Temperature Sensor is strongly recommended. Controller location, air flow, and system power can drastically affect the local temperature sensor reading. A RTS will provide optimal charging performance.*

### Remote Meter (Model: RM-1)

The digital *Remote Meter* displays system operating information, error indications, and a self-diagnostic read-out. Information is displayed on a backlit 4-digit custom LCD display. The large numerical display and icons are easy to read and large buttons make navigating the meter menus easy. Additionally, a status LED and three (3) battery SOC LEDs provide system status at a glance.

The meter can be flush-mounted in a wall or surface mounted using the mounting frame (included). The RM-1 is supplied with 33 ft (10.0 m) of cable, a mounting frame, and mounting screws. The RM-1 connects to the RJ- 11 meter port on the SunSaver MPPT.

### PC MeterBus Adapter™ (Model: MSC)

The *MSC* converts the MeterBus RJ-11 electrical interface to an isolated standard RS-232 interface which enables communication between the SunSaver MPPT and a personal computer (PC). The MSC (or UMC-1) is required for programming custom charging set-points, and for viewing logged data. See Sections 4.7 - *Programming Custom Set-points*, and 4.8 - *Data-logging*, for details

### Ethernet MeterBus Converter (EMC-1)

This product is an Ethernet gateway that provides web monitoring services, a Modbus TCP/IP server, and a local web page server. End users can collect information about their off-grid PV system remotely. The EMC-1 supports all products with MeterBus ports by bridging MODBUS TCP/IP requests to serve LiveView pages for each product.

### USB Communications Adapter (UMC-1)

A modular unit that uses a USB-B plug, usually from a USB A-B computer cable, and an RJ-11 plug to connect with a Morningstar controller's MeterBus port, for monitoring and programming using MSView PC software.

## 2.4 Regulatory Information



**NOTE:**

*This section contains important information for safety and regulatory requirements.*

The SunSaver-MPPT controller should be installed by a qualified technician according to the governing electrical regulations of the country in which the product will be installed.

SunSaver-MPPT controllers comply with the following EMC standards:

- Immunity: EN61000-6-2:1999
- Emissions: EN55022:1994 with A1 and A3 Class B1
- Safety: EN60335-1 and EN60335-2-29 (battery chargers)

**FCC requirements:**

This device complies with Part 15 of the FCC rules. Operation is subject to the following two conditions: (1) This device may not cause harmful interference, and (2) this device must accept any interference received, including interference that may cause undesired operation.

Changes or modifications not expressly approved by Morningstar for compliance could void the user's authority to operate the equipment.

**NOTE:**

This equipment has been tested and found to comply with the limits for a Class B digital device, pursuant to Part 15 of the FCC rules. These limits are designed to provide reasonable protection against harmful interference in a residential installation. This equipment generates, uses, and can radiate radio frequency energy and, if not installed and used in accordance with the instruction manual, may cause harmful interference to radio communication. However, there is no guarantee that interference will not occur in a particular installation. If this equipment does cause harmful interference to radio or television reception, which can be determined by turning the equipment on and off, the user is encouraged to try to correct the interference by one or more of the following measures:

- Re-orient or relocate the receiving antenna.
- Increase the separation between the equipment and receiver.
- Connect the equipment into an outlet on a circuit different from that to which the receiver is connected.
- Consult the dealer or an experienced radio/TV technician for help.

This Class B digital apparatus complies with Canadian ICES-003. Cet appareil numérique de la classe B est conforme a la norme NMB-003 du Canada.

## 3.0 Installation

### 3.1 General Installation Notes

- Read through the entire installation section first before beginning installation.
  - Be very careful when working with batteries. Wear eye protection. Have fresh water available to wash and clean any contact with battery acid.
  - Use insulated tools and avoid placing metal objects near the batteries.
  - Explosive battery gases may be present during charging. Be certain there is sufficient ventilation to release the gases.
  - Do not install in locations where water can enter the controller.
  - Loose power connections and/or corroded wires may result in resistive connections that melt wire insulation, burn surrounding materials, or **even cause fire**. Ensure tight connections and use cable clamps to secure cables and prevent them from swaying in mobile applications.
  - Only charge lead-acid or NiCd batteries.
  - The SunSaver MPPT Battery connection may be wired to one battery or a bank of batteries. The following instructions refer to a singular battery, but it is implied that the battery connection can be made to either one battery or a group of batteries in a battery bank.
- Stranded wires to be connected to the SunSaver-MPPT terminals should be prepared first with e.g. clamped copper heads, etc., to avoid the possibility of conductor strands coming free out of the connection screw, and possible contact with the metal enclosure.
  - Solar and battery fuses or DC breakers are required in the system. These protection devices are external to the SunSaver-MPPT controller, and must be a maximum of 22.5 Amps.
  - Maximum battery short-circuit current rating must be less than the interrupt current rating of the battery over-current protection device referenced above.

## 3.2 Configuration

The four (4) *Settings Switches* and the *Battery Select Jumper* are used to adjust the SS-MPPT battery type, load control, equalization, and communication settings. This section details the configuration for each setting.

### Select a Battery Type

The SS-MPPT provides four (4) different battery types as shown in Table 1 below. Use *Settings Switch 1* and the *Battery Select Jumper* to choose the battery type. See Section 7.0 - *Technical Specifications* for detailed charging information for each battery type.

The battery select jumper is secured in the terminal block between terminal #6 and terminal #7 as shown in Figure 2. The second column in Table 1 specifies whether the jumper should be removed or remain in place, depending on the desired battery type.

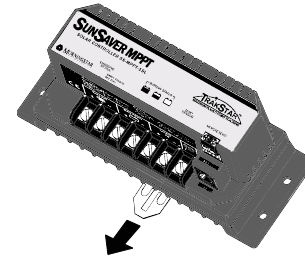

**Figure 2. Removing the Battery Select jumper.**

### Load Control – Low Voltage Disconnect / Reconnect

Choose between two (2) load control *Low Voltage Disconnect / Reconnect* settings.

SWITCH 2 OFF (↓): LVD = 11.50 V, LVR = 12.60 V  
 SWITCH 2 ON (↑): LVD = 11.00 V, LVR = 12.10 V<sup>2</sup>

(2) These values can be modified with custom programming. For more information, see Section 4.7 - *Programming Custom Set-points*.

### Enable or Disable Auto-Equalization

Turn the auto-equalize feature OFF or ON. The auto-equalize feature will administer an equalization charge (flooded battery type only) every 28 days. There is no equalization charging for gel or sealed battery types.

SWITCH 3 OFF (↓): AUTO-EQUALIZE OFF  
 SWITCH 3 ON (↑): AUTO-EQUALIZE ON  
 (AGM, flooded battery types only)

Battery Type	Battery Jumper	Switch 1
Gel <sup>1</sup>	INSERTED	ON (↑)
Sealed	INSERTED	OFF (↓)
AGM <sup>1</sup>	REMOVED	ON (↑)
Flooded	REMOVED	OFF (↓)

(1) Set-points for this switch setting can be modified with custom programming. For more information, see Section 4.7 - *Programming Custom Set-points*.

**Table 1. Battery Type selection**

## Communication – Meter / MODBUS®

Choose the desired communication protocol for the RJ-11 meter connection. Select the *Meter* protocol to communicate with a Morningstar Remote Meter (optional accessory).

Select the *MODBUS®* protocol to communicate with a PC<sup>2</sup> and Morningstar's MSView software. *MODBUS®* is an open communication protocol standard used by Morningstar's MSView PC software and other 3rd party hardware / software.

SWITCH 4 OFF (↓): MORNINGSTAR REMOTE METER

SWITCH 4 ON (↑): MODBUS® PROTOCOL FOR MSVIEW, 3RD PARTY DEVICES

(2) Morningstar PC Meterbus Adapter (Model: MSC) required. Not included. See Morningstar's website at: [www.morningstarcorp.com](http://www.morningstarcorp.com) for more information. .

MODBUS® is a registered trademark of Modbus-IDA ([www.modbus-ida.org](http://www.modbus-ida.org))

## 3.3 Mounting



**CAUTION:** *Equipment Damage or Risk of Explosion*  
Never install the SunSaver-MPPT in an enclosure with vented/flooded batteries. Battery fumes are flammable and will corrode and destroy the SunSaver circuits.



**CAUTION:** *Equipment Damage*  
When installing the SunSaver-MPPT in an enclosure, ensure sufficient ventilation. Installation in a sealed enclosure will lead to over-heating and a decreased product lifetime.



**PRUDENCE:** *Endommagement de l'équipement ou risque d'explosion*  
N'installez jamais le SunSaver-MPPT dans une enceinte avec des batteries à électrolyte liquide. Les vapeurs des batteries sont inflammables et corroderont et détruiront les circuits du SunSaver.



**PRUDENCE:** *Endommagement de l'équipement*  
Assurez une ventilation suffisante en cas d'installation du SunSaver-MPPT dans une enceinte. L'installation dans une enceinte hermétique entraîne une surchauffe et une réduction de la durée de vie du produit.

### Step 1: Choose Mounting Location

Locate the SunSaver-MPPT on a vertical surface protected from direct sun, high temperatures, and water.

### Step 2: Check for Clearance

Place the SunSaver-MPPT in the location where it will be mounted. Verify that there is sufficient room to run wires and that there is ample room above and below the controller for air flow.

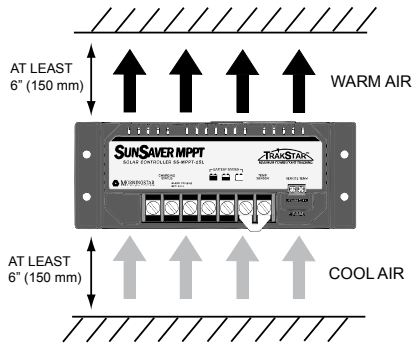

**Figure 3. Mounting and cooling**

### Step 3: Mark Holes

Use a pencil or pen to mark the four (4) mounting hole locations on the mounting surface.

### Step 4: Drill Holes

Remove the controller and drill 3/32" (2.5 mm) holes in the marked locations.

### Step 5: Secure Controller

Place the controller on the surface and align the mounting holes with the drilled holes in step 4. Secure the controller in place using the mounting screws (included).

## 3.4 Wiring



**NOTE:** A recommended connection order has been provided for maximum safety during installation.



**NOTE:** The SunSaver-MPPT is a negative ground controller. Any combination of negative connections can be earth grounded as required. Grounding is recommended, but not required for correct operation.



**NOTE:**  
To comply with the NEC, the SunSaver-MPPT must be installed using wiring methods in accordance with Article 690 of the latest edition of the National Electric Code, NFPA 70.



**NOTE:**  
The total current draw of all system loads connected to the SunSaver-MPPT LOAD terminals cannot exceed the controller's load current rating.



**NOTE:**  
For mobile applications, be sure to secure all wiring. Use cable clamps to prevent cables from swaying when the vehicle is in motion. Unsecured cables create loose and resistive connections which may lead to excessive heating and/or fire.



**WARNING:**  
**EXPLOSION HAZARD - DO NOT DISCONNECT WHILE CIRCUIT IS LIVE UNLESS AREA IS KNOWN TO BE NON-HAZARDOUS.**



**AVERTISSEMENT:**  
**RISQUE D'EXPLOSION. NE PAS DEBRANCHER TANT QUE LE CIRCUIT EST SOUS TENSION, A MOINS QU'IL NE S'AGISSE D'UN EMPLACEMENT NON DANGEREUX.**

## Step 1: Load Wiring

The SS-MPPT load output connection will provide battery voltage to system loads such as lights and other electronic devices. **Do not connect inductive loads such as inverters, motors, pumps, compressors, generators to the load terminals. Connect inductive loads directly to the battery.**

See Section 4.4 - Load Control Information for more details about load control.

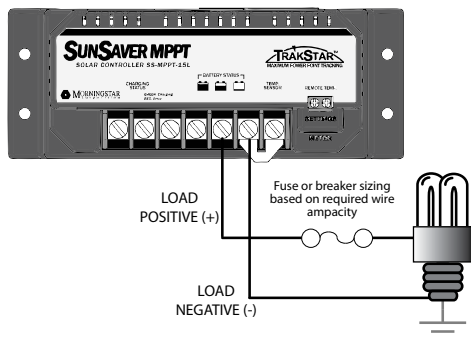

Figure 4. Load wiring

Connect positive (+) and negative (-) load wires to the system load(s) or load distribution panel as shown in Figure 4. Refer to the wire gauge chart on page 65 of this manual for correct wire sizing.

If required, the negative load connection may be earth grounded. Use appropriate gauge wire and proper grounding methods for the installation site.

An in-line fuse holder should be wired in series in the load positive (+) wire as shown. **DO NOT INSERT A FUSE AT THIS TIME.**

If wiring the load connection to a load distribution panel, each load circuit should be fused separately. The total load draw should not exceed the 15A load rating.

## Step 2: Battery Wiring



**WARNING: Shock Hazard**  
Fuses, circuit breakers, and disconnect switches should never open grounded system conductors. Only GFDI devices are permitted to disconnect grounded conductors.



**AVERTISSEMENT: Risque de décharge électrique**  
Les fusibles, coupe-circuits et interrupteurs ne doivent jamais ouvrir les conducteurs du système mis à la terre. Seuls les dispositifs GFDI sont autorisés à déconnecter les conducteurs reliés mis à la terre.

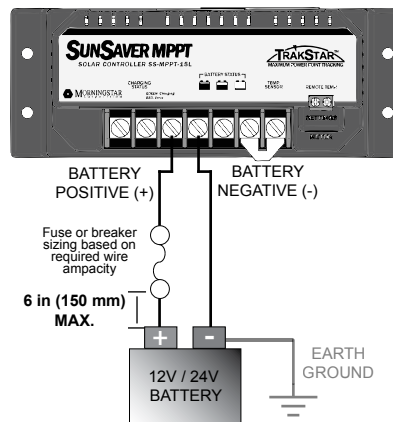

Figure 5. Battery wiring.

Before connecting the battery, measure the battery voltage. It must be over 7 Volts to power the controller. For 24 Volt systems, the battery voltage must be greater than 15.5 Volts to properly detect a 24V battery. The 12/24 Volt battery detection is automatic and the check is only performed at start-up.



### Step 3: Solar Wiring

Connect the battery to the SS-MPPT. Refer to the wire gauge chart on page 65 of this manual for correct wire sizing.

If required, the negative battery connection may be earth grounded. Use appropriate gauge wire and proper grounding methods for the installation site. Grounding wires must be of the same, or greater, cross-sectional area as the PV wires.

Wire an in-line fuse holder no more than 6 inches (150 mm) from the battery positive terminal. **DO NOT INSERT A FUSE AT THIS TIME.**



**WARNING: Shock Hazard**

*The solar PV array can produce open-circuit voltages in excess of 60 Vdc when in sunlight. Verify that the solar input breaker or disconnect has been opened (disconnected) before installing the system wires.*



**AVERTISSEMENT: Risque de décharge électrique**  
*Le réseau PV solaire peut produire des tensions de circuit ouvert supérieures à 60 V cc à la lumière du soleil. Vérifiez que le coupe-circuit ou l'interrupteur d'entrée solaire a été ouvert (déconnexion) avant d'installer les câbles du système.*



**WARNING: Risk of Damage**

*Connecting the solar array to the battery terminal will permanently damage the SunSaver-MPPT.*



**AVERTISSEMENT : Risque d'endommagement**

*La connexion du réseau solaire sur la borne de la batterie endommagera le SunSaver de façon permanente.*

The SunSaver MPPT can accept 12, 24, or 36V nominal off-grid solar module arrays. Grid-tie solar module(s) may be used if the open circuit voltage ( $V_{oc}$ ) does not exceed the SS-MPPT 60 Volt maximum solar input rating. The solar module(s) nominal voltage must be equal to or greater than the nominal battery voltage. For 24 Volt systems, a 24, or 36V nominal solar array must be used.

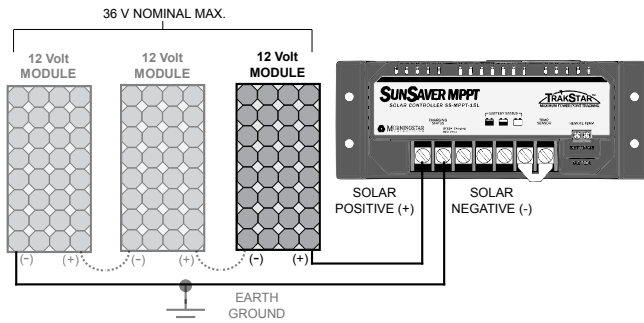

**Figure 6. Solar input wiring.**

Connect the solar module(s) to the SS-MPPT. Refer to the wire gauge chart on page 65 of this manual for correct wire sizing.

If required, the negative solar connection may be earth grounded. Use appropriate gauge wire and proper grounding methods for the installation site.

#### Step 4: Optional Accessories

Install the *Remote Temperature Sensor* and *Remote Meter* (both purchased separately) if required. Refer to the instructions provided with each accessory for detailed installation procedures.



**WARNING: Risk of Fire.**

If no *Remote Temperature Sensor (RTS)* is connected, use the *SunSaver-MPPT* within 3m (10 ft) of the batteries. Internal temperature compensation will be used if the RTS is not connected. Use of the RTS is strongly recommended.



**AVERTISSEMENT: Risque d'incendie.**

Si non *Capteur de température distant (RTS)* est connecté, utilisez le MPPT ProStar moins de 3m (10 pi) de les batteries. Compensation de la température interne sera utilisée si la RTS n'est pas connecté. Utilisation de la RTS est fortement recommandé.

## Step 5: Confirm Wiring

Double-check the wiring in steps 1 through 4. Confirm correct polarity at each connection. Verify that all seven (7) SS-MPPT power terminals are tightened.

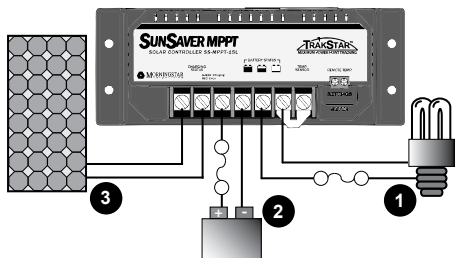

Figure 7. System Wiring Review

## Step 6: Install Fuses

Install a properly sized DC-rated fuse in each fuse holder in the following order:

1. Load circuit
2. Battery circuit

## Step 7: Confirm Power-up

The SS-MPPT should begin the power-up LED sequence when battery power is applied. Observe that the Battery Status LEDs blink in sequence one time.

If the SS-MPPT does not power up or a flashing LED error sequence exists, refer to Section 6.0 - *Troubleshooting*.

## 4.0 Operation

### 4.1 LED Indications

#### STATUS LED

The Status LED indicates charging status and any existing solar input error conditions. The Status LED is on when charging during the day and off at night. The Status LED will flash red whenever an error condition(s) exists. Table 2 lists the Status LED indications.

Color	Indication	Operating State
None	Off (with heartbeat <sup>1</sup> )	Night
Green	On Solid (with heartbeat <sup>2</sup> )	Charging
Red	Flashing	Error
Red	On Solid (with heartbeat <sup>2</sup> )	Critical Error

<sup>1</sup> heartbeat indication flickers the Status LED on briefly every 5 seconds

<sup>2</sup> heartbeat indication flickers the Status LED off briefly every 5 seconds

Table 2. Status LED definitions

For more information on Status LED errors, see Section 5.1 - *Error Indications*.

## BATTERY SOC LEDS

Three (3) battery *state-of-charge* LEDs indicate the level of charge on the battery. The SOC indication is based on battery voltage set-points alone, which only provides an approximation of the actual state of charge of the battery.

Table 3 lists the SOC LED indications.

SOC LED	Indication	Battery Status	Load Status
Green	Fast Flashing (2 Flash / sec)	Equalize Charge	Load On
Green	Med. Flashing (1 Flash / sec)	Absorption Charge	Load On
Green	Slow Flashing (1 Flash / 2 sec)	Float Charge	Load On
Green	On solid	Nearly Full	Load On
Yellow	On solid	Half Full	Load On
Red	Flashing (1 Flash / sec)	Battery Low	LVD Warning (Load On)
Red	On solid	Battery Empty	LVD (Load Off)

**Table 3. Battery SOC LED definitions**



**NOTE:**

An error condition exists if multiple Battery SOC LEDs are flashing. See Section 5.1 Error Indications for more information.

## 4.2 TrakStar™ MPPT Technology

The SS-MPPT utilizes Morningstar's *TrakStar Maximum Power Point Tracking* technology to extract maximum power from the solar module(s). The tracking algorithm is fully automatic and does not require user adjustment. Trakstar technology will track the array *maximum power point voltage* ( $V_{mp}$ ) as it varies with weather conditions, ensuring that maximum power is harvested from the array through the course of the day.

### Current Boost

In many cases, TrakStar MPPT technology will “boost” the solar charge current. For example, a system may have 2 Amps of solar current flowing into the SS-MPPT and 5 Amps of charge current flowing out to the battery. The SS-MPPT does not create current! Rest assured that the power into the SS-MPPT is the same as the power out of the SS-MPPT. Since power is the product of Voltage and current (Volts x Amps), the following is true\*:

- (1) Power Into the SS-MPPT = Power Out of the SS-MPPT
- (2) Volts In x Amps In = Volts Out x Amps Out

\* assuming 100% efficiency. losses in wiring and conversion exist.

If the solar module's  $V_{mp}$  is greater than the battery voltage, it follows that the battery current must be proportionally greater than the solar input current so that input and output power are balanced. The greater the difference between the maximum power Voltage and battery Voltage, the greater the current boost. Current boost can be substantial in systems where the solar array is of a higher nominal voltage than the battery as described in the next section.

## High Voltage Strings and Grid-tie Modules

Another benefit of TrakStar MPPT technology is the ability to charge 12 or 24 Volt batteries with solar arrays of higher nominal voltages. A 12V battery bank can be charged with a 12 V, 24 V, or 36 V nominal off-grid solar array. Certain grid-tie solar modules may also be used as long as the solar array *open circuit Voltage* ( $V_{oc}$ ) rating will not exceed the SS-MPPT 60V maximum input Voltage rating at worst-case (coldest) module temperature. The solar module documentation should provide  $V_{oc}$  vs. temperature data.

Higher solar input voltage results in lower solar input current for a given input power. High voltage solar input strings allow for smaller gauge solar wiring. This is especially helpful for systems with long wiring runs between the solar array and the SS-MPPT.

## An Advantage Over Traditional Controllers

Traditional controllers connect the solar module directly to the battery when recharging. This requires that the solar module operate in a voltage range that is below the module's  $V_{mp}$ . In a 12 V system for example, the battery voltage may range from 10 - 15 Vdc but the module's  $V_{mp}$  is typically around 17 V. Figure 8 shows a typical current vs. voltage output curve for a nominal 12V off-grid module.

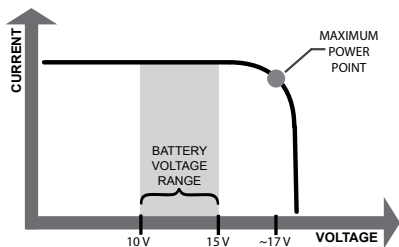

Figure 8. Nominal 12 V Solar Module I-V curve

The array  $V_{mp}$  is the voltage where the product of current and voltage (Amps x Volts) is greatest, which falls on the “knee” of the solar module I-V curve as shown in Figure 8.

Because traditional controllers do not operate at the  $V_{mp}$  of the solar array, energy is wasted that could otherwise be used to charge the battery and power system loads. The greater the difference between battery voltage and the  $V_{mp}$  of the module, the more energy is wasted.

TrakStar MPPT technology will always operate at the  $V_{mp}$  resulting in less wasted energy compared to traditional controllers.

## 4.3 Battery Charging

The SunSaver MPPT has a 4-stage battery charging algorithm for rapid, efficient, and safe battery charging. Figure 9 shows the sequence of the stages.

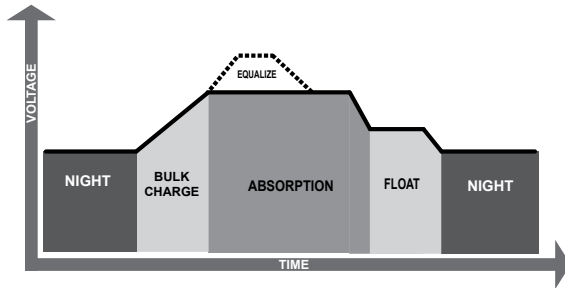

Figure 9. SunSaver MPPT charging algorithm

### Bulk Charging

In this stage, the battery voltage has not yet reached absorption voltage and 100% of available solar power is used to recharge the battery.

### Absorption

When the battery has recharged to the Absorption voltage set-point, constant voltage regulation is used to prevent heating and excessive battery gassing.

### Float

After the battery is fully charged the SS-MPPT reduces the battery voltage to a float charge which is sometimes called a *trickle charge*.

Depending on battery history, the battery remains in the absorption stage for 3 or 4 hours before transitioning to the float stage.

### Equalize (flooded battery type only)

If the auto-equalize feature is enabled, the SS-MPPT will equalize a flooded battery for three (3) hours every 28 days. Equalize charging raises the battery voltage above the standard absorption voltage so that the electrolyte gases. This process prevents electrolyte stratification and equalizes the individual cell voltages within the battery.



**WARNING: Risk of Explosion**  
Equalizing vented batteries produces explosive gases. The battery bank must be properly ventilated.



**CAUTION: Equipment Damage**  
Excessive overcharging and gassing too vigorously can damage the battery plates and cause shedding of active material from the plates. An equalization that is too high or for too long can be damaging. Review the requirements for the particular battery being used in your system.



**AVERTISSEMENT: Risque d'explosion**  
Les batteries à évent et compensation produisent des gaz explosifs. Le groupe de batteries doit être correctement ventilé.



**PRUDENCE:** *Endommagement de l'équipement Une surcharge excessive et un dégagement gazeux trop vigoureux peuvent endommager les plaques de batteries et provoquer l'élimination du matériau actif des plaques. Une compensation trop élevée ou trop longue peut provoquer des dégâts. Examinez les exigences pour la batterie particulière utilisée dans votre système.*

## 4.4 Load Control Information

The primary purpose of the load control function is to disconnect system loads when the battery has discharged to a low state of charge, and reconnect system loads when the battery is sufficiently recharged. System loads may be lights, DC appliances, or other electronic devices. The total current draw of all loads must not exceed the SS-MPPT 15 Amp maximum load rating.



**CAUTION:** *Do not wire any AC inverter or other inductive load such as a motor, pump, compressor or generator to the load terminals of the SunSaver MPPT. Damage to the load control circuit may result. Wire inductive loads directly to the battery or battery bank.*



**ATTENTION :** *Ne pas raccorder un inverseur ou autre charge inductive comme le moteur, pompe, compresseur ou générateur aux bornes de la SunSaver MPPT. Pourrait endommager le circuit de commande de charge. Fil de charges inductives directement sur la batterie ou la batterie.*

### Load Control Settings

Load control is fully automatic. Choose between two (2) factory Low Voltage Disconnect (LVD) and Low Voltage Reconnect (LVR) settings by adjusting Switch #2. See Section 3.2 - *Configuration* for more information.

## Current Compensation

All LVD and LVR set-points are current compensated. Under load, the battery voltage will sag in proportion to the current draw of the load. A short-term large load could cause a premature LVD without the current compensation feature. LVD and LVR set-points are adjusted lower per the following table.

System Voltage	Current Compensation
12 Volt	-15 mV per amp of load
24 Volt	-30 mV per amp of load

**Table 4. Current compensation values.**

## LVD Warning

As the battery discharges, the *Battery Status* LEDs will transition from green to yellow and then from yellow to flashing red. The flashing red indication is a warning that a low voltage disconnect event will occur soon. The amount of time between a green SOC indication and load disconnect will depend on many factors including:

- rate of discharge (amount of load draw)
- capacity of the battery
- health of the battery
- LVD set-point

If the battery discharges to the LVD set-point, the load will disconnect and a solid red Battery Status LED indication will be displayed.

## General Load Control Notes

- Without custom programming, the SunSaver-MPPT limits regulation voltage due to temperature compensation to a maximum of 15V (30V @ 24V nominal). This protects certain DC loads that may be damaged by high regulated input voltage.

- Do not wire multiple SunSaver MPPT load outputs together in parallel to power DC loads with a current draw greater than 15A. Equal current sharing cannot be guaranteed and an over-load condition will likely occur on one or more controllers.
- Exercise caution when connecting loads with specific polarity to a live load circuit. A reverse polarity connection may damage the load. Always double check load connections before applying power.

## 4.5 Protections

### Solar High Voltage Disconnect (HVD - temp. comp.)

(Charging status LED: R flashing) The battery is protected against excessive solar voltage. With the battery at 0.5V above its temperature compensated charging stage set-point, the array will be disconnected. The reconnect (HVR) will occur at 13.8 (12V system) or 27.6V (24V system) .

### Solar Overload

(No LED indication) The SunSaver MPPT will limit battery current to the 15 Amp maximum rating. An over-sized solar array will not operate at peak power. The solar array should be less than the SS-MPPT *nominal max. input power rating* for optimal performance. See Section 7.0 - *Technical Specifications* for more information.

### Solar Short Circuit

(Charging Status LED: OFF) Solar input power wires are short-circuited. Charging automatically resumes when the short is cleared.

### Load Short Circuit

(Battery Status LEDs: R/Y-G sequencing) Fully protected against load wiring short-circuits. After two (2) automatic load reconnect attempts (10 seconds between each attempt), the fault must be cleared by removing and re-applying power.

### Load Overload

(Battery Status LEDs: R/Y-G sequencing) If the load current exceeds the maximum load current rating, the SS-MPPT will disconnect the load. The greater the overload the faster the load will be disconnected. A small overload could take a few minutes to disconnect.

The SS-MPPT will attempt to reconnect the load two (2) times. Each attempt is approximately 10 seconds apart. If the overload remains after two (2) attempts, the load will remain disconnected until power is removed and re-applied.

### Load High Voltage Disconnect (HVD)

(Battery status LEDs: G-R sequencing) Loads are protected against excessive battery voltage. With the battery at 15.3V for 12V nominal and 30.6V for 24V nominal, the load will be disconnected. The reconnect (HVR) will occur at 14.5 (12V system) or 29V (24V system).

### High Voltage Input

(Charging Status LED: R flashing) If the solar input open circuit voltage ( $V_{oc}$ ) exceeds the 75 Volt fault threshold, the array will remain disconnected until the  $V_{oc}$  falls safely back below this voltage level. Maximum design input voltage should not exceed 60.

### Solar Reverse Polarity

(No LED indication) Fully protected against reverse solar connection. No damage to the controller will result. Correct the miswire to resume normal operation.



### Battery Reverse Polarity

(No LED indication) Fully protected against reverse battery connection. No damage to the controller will result. Correct the miswire to resume normal operation.

### Damaged Local Temperature Sensor

(Charging Status LED: R solid) The local ambient temperature sensor is short-circuited or damaged. Charging stops to avoid over or under-charging. This is a critical error. Contact your authorized Morningstar dealer for service.

### Damaged Internal Temperature Sensor

(Charging Status LED: R solid) The internal heatsink temperature sensor is damaged. This is a critical error. Contact your authorized Morningstar dealer for service.

### High Temperature

(Battery Status LEDs: R-Y sequencing) The heatsink temperature has exceeded safe limits and the load is disconnected. The load will automatically reconnect when the heatsink cools to a safe temperature.

### Remote Temperature Sensor (RTS)

(Battery Status LEDs: R/Y - G/Y sequencing) A bad RTS connection or a severed RTS wire has disconnected the temperature sensor during charging. Charging automatically resumes when the problem is fixed. To resume operation without an RTS, disconnect all power to the SunSaver MPPT, and then reconnect.

### High Voltage Transients

Solar, battery, and load power connections are protected against high voltage transients. In lightning prone areas,

additional external suppression is recommended.

## 4.6 Inspection and Maintenance



### **WARNING: RISK OF ELECTRICAL SHOCK.**

*NO POWER OR ACCESSORY TERMINALS ARE ELECTRICALLY ISOLATED FROM DC INPUT, AND MAY BE ENERGIZED WITH HAZARDOUS SOLAR VOLTAGE. UNDER CERTAIN FAULT CONDITIONS, BATTERY COULD BECOME OVER-CHARGED. TEST BETWEEN ALL TERMINALS AND GROUND BEFORE TOUCHING.*



### **AVERTISSEMENT: RISQUE DE CHOC ÉLECTRIQUE.**

*NON ALIMENTATION OU AUX BORNES D'ACCESSOIRES SONT ISOLÉS ÉLECTRIQUEMENT DE L'ENTRÉE DE C.C ET DOIT ÊTRE ALIMENTÉS À UNE TENSION DANGEREUSE SOLAIRE. SOUS CERTAINES CONDITIONS DE DÉFAILLANCE, LA BATTERIE POURRAIT DEVENIR TROP CHARGÉE. TEST ENTRE TOUTES LES BORNES ET LA MASSE AVANT DE TOUCHER.*



### **WARNING: Shock Hazard**

*Disconnect all power sources to the controller before removing the wiring box cover. Never remove the cover when voltage exists on the SunSaver-MPPT power connections.*



### **AVERTISSEMENT: Risque de décharge électrique**

*Un moyen de déconnexion de tous les poteaux d'alimentation doit être fourni. Ceux-ci se déconnecte doit être intégrée dans le câblage fixe. Ouvrir que toutes les source d'énergie se déconnecte avant de retirer le couvercle de la contrôleur, ou accès au câblage.*

The following inspections and maintenance tasks are recommended at least two times per year for best controller performance.

- Tighten all terminals. Inspect for loose, broken, or corroded connections.
- Verify that all wire clamps and tie-downs are secure.
- Check that the controller is mounted in a clean, protected environment; free of dirt, insects, nests, and corrosion.
- If applicable, check enclosure ventilation and air flow holes for obstructions.
- Verify LED indication is consistent with the present system conditions.
- Verify that the Remote Temperature Sensor (if used) is securely attached to the RTS terminals.

## 4.7 Programming Custom Set-points



**CAUTION:** *This feature should only be used by advanced users who have very specific charging and/or load control requirements that are not met using the factory default charge and load control settings. The factory default settings will be sufficient for the vast majority of users.*

Custom charging and load set-points can be programmed into SS-MPPT non-volatile memory using a PC with Morningstar *MSView* software installed, and a *Meterbus to Serial Adapter* (Model: MSC) or a *USB Meterbus Converter* (Model: UMC-1). Refer to the *MSView* help files for detailed instructions. *MSView* PC software is available at no charge on our website at:

[www.morningstarcorp.com](http://www.morningstarcorp.com)

The SS-MPPT Set-up Wizard will guide you through the set-point configuration process. Refer to *MSView* Help files for more information.

To use custom set-points, the Settings Switches must be adjusted as follows:

**SWITCH #1 ON (↑) TO USE CUSTOM CHARGING SET-POINTS.**  
USE THE BATTERY SELECT JUMPER TO SELECT BETWEEN TWO SETS OF CUSTOM CHARGING SET-POINTS.

**SWITCH #2 ON (↑) TO USE CUSTOM LOAD CONTROL SET-POINTS.**



**NOTE:** *Use the custom settings wizard to configure and program the controller for Lighting load control. This functionality can only be enabled through custom settings.*



**NOTE:** *Programming custom set-points will overwrite the default Gel and AGM battery type values programmed into custom memory at the factory. Document the new custom values in this manual for future reference.*

## 4.8 Data-logging

The SS-MPPT creates a thirty day internal data log of key PV system information. The log can be accessed and viewed by downloading and running MSView PC software, available at no charge at:

[www.morningstarcorp.com](http://www.morningstarcorp.com)

Internal data logged:

- Daily min. and max. battery voltages
- Daily Ah charge to battery
- Daily Ah charge to load
- Daily array faults
- Daily load faults
- Max. daily array voltage
- Daily time in Absorption
- Daily time in Equalization
- Daily time in Float

Connect a PC to the SS-MPPT RJ-11 jack. The UMC-1, or MSC, adaptor accessory, and an RJ-11 cable are needed to connect the serial cable from the PC with the SS-MPPT.

Start the MSView program, and use the Help topics such as, “Making a Connection” and “Displaying Data”, to proceed.

Variables can also be custom logged and graphed using MSView Display windows. See the Help topics in MSView for more information.

## 5.0 Troubleshooting



### **WARNING: RISK OF ELECTRICAL SHOCK.**

NO POWER OR ACCESSORY TERMINALS ARE ELECTRICALLY ISOLATED FROM DC INPUT, AND MAY BE ENERGIZED WITH HAZARDOUS SOLAR VOLTAGE. UNDER CERTAIN FAULT CONDITIONS, BATTERY COULD BECOME OVER-CHARGED. TEST BETWEEN ALL TERMINALS AND GROUND BEFORE TOUCHING.



### **AVERTISSEMENT: RISQUE DE CHOC ÉLECTRIQUE.**

NON ALIMENTATION OU AUX BORNES D'ACCESSOIRES SONT ISOLÉS ÉLECTRIQUEMENT DE L'ENTRÉE DE C.C ET DOIT ÊTRE ALIMENTÉS À UNE TENSION DANGEREUSE SOLAIRE. SOUS CERTAINES CONDITIONS DE DÉFAILLANCE, LA BATTERIE POURRAIT DEVENIR TROP CHARGÉE. TEST ENTRE TOUTES LES BORNES ET LA MASSE AVANT DE TOUCHER.



### **WARNING: Shock Hazard**

*A means of disconnecting all power supply poles must be provided. These disconnects must be incorporated in the fixed wiring. Open all power source disconnects before removing controller wiring cover, or accessing wiring.*



## **AVERTISSEMENT: Risque de décharge électrique.**

Un moyen de déconnexion de tous les poteaux d'alimentation doit être fourni. Ceux-ci se déconnecte doit être intégrée dans le câblage fixe. Ouvrir que toutes les source d'énergie se déconnecte avant de retirer le couvercle de la contrôleur, ou accès au câblage.

### 5.1 Error Indications



*NOTE: If an optional Morningstar Remote Meter is attached to the SunSaver MPPT, use the self-diagnostic feature to determine the cause of the error indication.*

*Refer to the Remote Meter Operator's Manual for more information.*

#### **Status LED Error Indications**

- |                                 |                        |
|---------------------------------|------------------------|
| • Solar High Voltage Disconnect | Flashing red           |
| • RTS Shorted                   | Flashing red           |
| • RTS Disconnected              | Flashing red           |
| • Damaged local temp. sensor    | Solid red <sup>1</sup> |
| • Damaged heatsink temp. sensor | Solid red <sup>1</sup> |
| • Damaged input MOSFETs         | Solid red <sup>1</sup> |
| • Firmware Error                | Solid red <sup>1</sup> |

1. Heartbeat indication flickers the Status LED off briefly every 5 seconds

#### **Battery Status LED Error Indications**

- |                                |                      |
|--------------------------------|----------------------|
| • Load High Voltage Disconnect | R-G sequencing       |
| • High Temperature Disconnect  | R-Y sequencing       |
| • Remote Temp. Sensor Error    | Y/R - G/Y sequencing |
| • External Wiring Error        | G/R-Y sequencing     |
| • Load Overcurrent             | Y/R-G sequencing     |
| • Load Short Circuit           | G/R-Y sequencing     |
| • Custom Programming Fault     | R-Y-G sequencing     |
| • Self-test Error              | R-Y-G sequencing     |

### 5.2 Common Problems

**Problem:** No LED indications

**Solution:** With a multi-meter, check the voltage at the battery terminals on the SS-MPPT. Battery voltage must be at least 7V to power the SS-MPPT.

**Problem:** The SS-MPPT is not charging the battery.

**Solution:** If the Status LED is solid or flashing red, see Section 5.1 - *Error Indications*. If the Status LED is off, measure the voltage across the Solar input terminals of the SS-MPPT. Input voltage must be greater than battery voltage. Check fuses and solar wiring connections. Check solar array for shading.

**Full testing documentation is available on our website at:**

<http://support.morningstarcorp.com/>

## 6.0 Warranty and Policies

The SunSaver MPPT charge controller is warranted to be free from defects in material and workmanship for a period of FIVE (5) years from the date of shipment to the original end user. Morningstar will, at its option, repair, or replace, any such defective products.

### WARRANTY EXCLUSIONS AND LIMITATIONS

This warranty does not apply under the following conditions:

- Damage by accident, negligence, abuse or improper use.
- PV or load currents exceeding the ratings of the product.
- Unauthorized product modification or attempted repair.
- Damage occurring during shipment.

THE WARRANTY AND REMEDIES SET FORTH ABOVE ARE EXCLUSIVE AND IN LIEU OF ALL OTHERS, EXPRESS OR IMPLIED. MORNINGSTAR SPECIFICALLY DISCLAIMS ANY AND ALL IMPLIED WARRANTIES, INCLUDING, WITHOUT LIMITATION, WARRANTIES OF MERCHANTABILITY AND FITNESS FOR A PARTICULAR PURPOSE. No Morningstar distributor, agent or employee is authorized to make any modification or extension to this warranty.

MORNINGSTAR IS NOT RESPONSIBLE FOR INCIDENTAL OR CONSEQUENTIAL DAMAGES OF ANY KIND, INCLUDING BUT NOT LIMITED TO LOST PROFITS, DOWNTIME, GOODWILL OR DAMAGE TO EQUIPMENT OR PROPERTY.

## MORNINGSTAR TECHNICAL SUPPORT POLICIES

Morningstar's Technical Support Group is dedicated to providing unparalleled customer support.

### MS Support Scope:

1. Determining correct or failed functionality of a Morningstar product or system of Morningstar devices. It is expected that owners/operators will use manuals (including troubleshooting sections) before requesting technical support.
2. Providing product warranty replacements in accordance with the terms of Morningstar's warranty policy.
3. Assisting with the operability of all product / system features and functions described in Morningstar manuals and datasheets.

### Please be advised:

◆ The Morningstar Technical Support Group generally provides referrals for requested system consultations or design/configuration/sizing services. Distributors, dealers, system designers, installers and vast online resources - including the String Calculator array design tool (at [www.morningstarcorp.com](http://www.morningstarcorp.com)) - are available to assist in these areas. Morningstar can help refer customers to a nearby authorized distributor, dealer, or installer if assistance is required in designing a renewable energy system that best suits your specific needs.

## MORNINGSTAR TECHNICAL SUPPORT POLICIES (Cont.)

◆ **Please visit the Tech Support section at [www.morningstarcorp.com](http://www.morningstarcorp.com) for any documentation or specification needs before requesting support.** The site also offers an array sizing tool (String Selector), product comparison tool (Product Comparator) and articles on solar charging technologies and other design considerations.

◆ Although emergencies do arise when a phone call is necessary, e-mail is the best way to contact us, and will result in the quickest response. Please use the support request form Contact Us (preferred), or e-mail us directly at [support@morningstarcorp.com](mailto:support@morningstarcorp.com)

Thank you for your business, and we look forward to assisting you.

## WARRANTY CLAIM PROCEDURE

1. Before proceeding, please refer to product manual, including Troubleshooting section.
2. Contacting your authorized Morningstar distributor or dealer from whom you purchased the unit is the first step in the warranty process. Local dealers can often address warranty issues quickly.
3. If supplier is unable to address the issue, please contact Morningstar by e-mail ([support@morningstarcorp.com](mailto:support@morningstarcorp.com)) with:
  - (A) purchase location -- business or company name
  - (B) full model and serial numbers (SN is 8-digits on unit bar label)
  - (C) failure behavior, including LED indications
  - (D) array configuration, panel Pmax, Voc, Vmp, Isc, and nominal battery voltage; these specifications are needed to receive assistance.
  - (E) multi-meter available (for field troubleshooting)
4. After warranty replacement has been approved and new unit(s) received, please return failed unit(s) using pre-paid shipping label, and follow any product specific instructions if requested by Morningstar Warranty Dept.
5. If instructed by Morningstar, after warranty replacement shipment has been received, return of failed unit(s) is required before further warranty replacements can be considered for the original or future cases.

**NOTE: Please do not return units without an RMA or case number. Doing so will increase the time required to resolve your claim.**

## 7.0 Technical Specifications

### Electrical

Nominal system voltage	12 or 24 Vdc
Max. battery current	15A
Battery Voltage range	7 – 36V
Max. solar input voltage	60V
Nominal maximum input power*	
12 Volt	200 Watts
24 Volt	400 Watts
Self-consumption	35 mA
Accuracy	
Voltage	1.0 %
Current	2.0 %
Meter Connection	6-pin RJ-11
Transient Surge Protection	4 x 1500 W

\* These power levels refer to the maximum wattage the SS-MPPT-15L can process at a certain system voltage. Higher power arrays can be used without damaging the controller, but array cost-benefit will be reduced at power levels much beyond the nominal ratings.

### Battery Charging

Regulation Method	4-stage
Temp. Compensation Coefficient	-5 mV / °C / cell (25°C reference)
Temp. Compensation Range	- 30°C to + 60°C
Temp. Compensated Set-points	Absorption, Float, Equalize, Solar HVD / HVR

### Battery Status LEDs

	Falling V	Rising V	
G to Y	12.1	13.1	Y to G
Y to Flash R	11.7	12.6	Flash R to Y
Flash R to R	11.5	12.6	R to Y

**Note:** Multiply x2 for 24 Volt systems.

### Battery Set-points

	Gel	Sealed	AGM	Flooded
Absorption Voltage	14.0V	14.1V	14.3V	14.4V
Float Voltage	13.7V	13.7V	13.7V	13.7V
Time until Float	3 hr	3 hr	3 hr	3 hr
Equalize Voltage	NA	NA	14.5V	14.9V
Equalize Duration	NA	NA	3 hrs	3 hrs
Equalize Calendar (days)	NA	NA	28	28
Max. Regulation Voltage <sup>1</sup>	15 / 30V			
LVD <sup>2</sup> / LVR <sup>2</sup> #1	12.6V / 12.1V @12V			
LVD <sup>2</sup> / LVR <sup>2</sup> #2	11.5V / 11.0V @12V			
Load HVD	15.3 / 30.6V			
Load HVR	14.5 / 29V			
Array HVD (temp. comp.)	Charging stage set-point +0.5V			
Array HVR (temp. comp.)	13.8V			

<sup>1</sup> Not temperature compensated. 15V @12V nominal, 30V @24V nominal  
<sup>2</sup> Adjustable by switch, not temperature compensated. 11.0V / 12.1V setting can be modified in custom settings.



**NOTE:** Temperature compensation increases regulation voltage in cold temperature. A 15V (30 V @ 24V nominal) maximum battery voltage limit prevents damage to sensitive DC loads.

### Environmental

Max. Operating Altitude	2000 meters
Ambient Temperature Range	-40°C to +60°C
Storage temperature	-55°C to +100°C
Humidity	100% N.C.
Enclosure	IP10 (indoor)

## Mechanical

Power terminals wire size (max.)	
Solid	#6 AWG / 16 mm <sup>2</sup>
Multistrand	#6 AWG / 16 mm <sup>2</sup>
Fine strand	#8 AWG / 10 mm <sup>2</sup>
Terminal Diameter	0.210 in / 5.4 mm
Power terminals torque (max.)	10.6 in-lb / 1.2 Nm
RTS terminals wire size (max.)	
Wire gauge (min)	#22 AWG / 0.3 mm <sup>2</sup>
Wire gauge (max)	#12 AWG / 3.0 mm <sup>2</sup>
RTS terminals torque (max.)	3.5 in-lb / 0.4 Nm
Dimensions	See inside front cover
Weight	1.3 lbs / 0.60 kg

## Efficiency and De-ratings

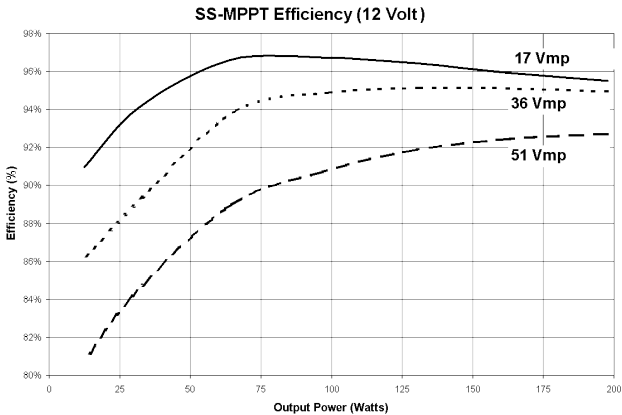

Figure 10. SS-MPPT 12 Volt Efficiency Curves

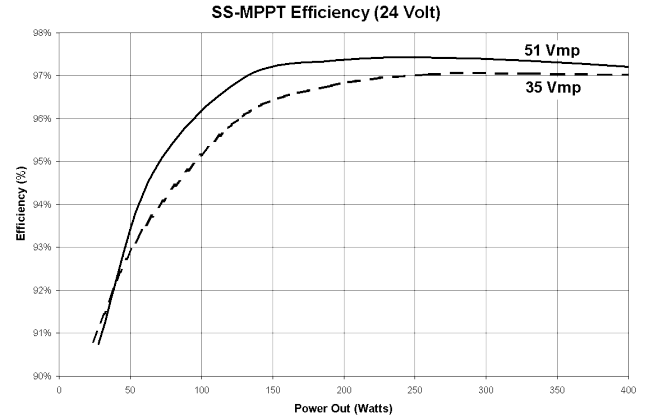

Figure 11. SS-MPPT 24 Volt Efficiency Curves

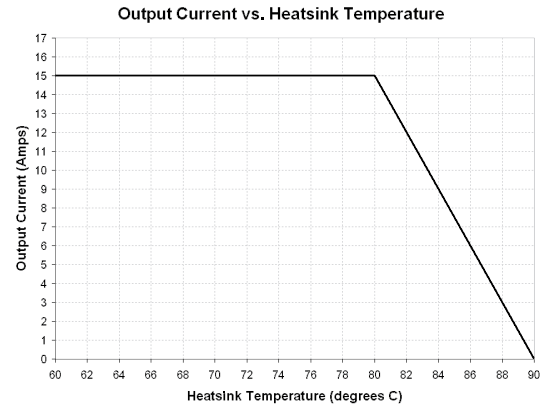
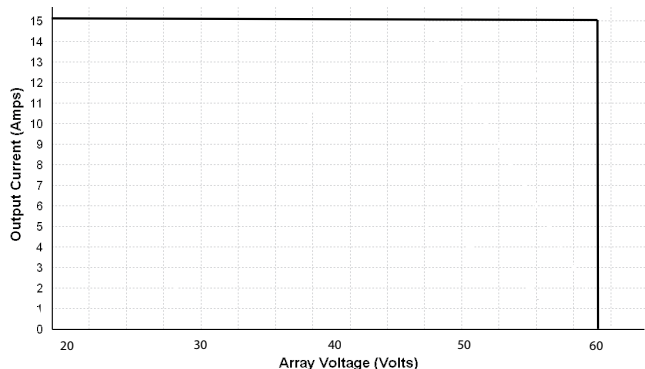

Figure 12. Output Current vs. Heatsink Temperature



# APPENDIX

## 12 Volt Nominal Wiring Chart



**Figure 13. Output Current vs. Array Voltage**

Amps	One-way Wire Distance (feet) Wire Gauge (AWG)					One-way Wire Distance (meters) Wire Gauge (mm <sup>2</sup> )				
	14	12	10	8	6	2.0	3.0	5.0	8.0	13.0
2	70	112	180	287	456	21	34	55	87	139
4	35	56	90	143	228	11	17	27	44	69
8	18	28	45	72	114	5	8	14	22	35
12	12	19	30	48	76	4	6	9	15	23
15	9	15	24	38	61	3	5	7	12	19

3% voltage drop, annealed copper wire at 20°C

## 24 Volt Nominal Wiring Chart

Amps	One-way Wire Distance (feet) Wire Gauge (AWG)					One-way Wire Distance (meters) Wire Gauge (mm <sup>2</sup> )				
	14	12	10	8	6	2.0	3.0	5.0	8.0	13.0
2	140	224	360	574	912	43	68	110	175	278
4	70	112	180	286	456	21	34	55	87	139
8	36	56	90	144	228	11	17	27	44	69
12	24	38	60	96	152	7	12	18.3	29	46
15	18	30	48	76	122	5	9	15	23	37

3% voltage drop, annealed copper wire at 20°C

## 36 Volt Nominal Wiring Chart

Amps	One-way Wire Distance (feet) Wire Gauge (AWG)					One-way Wire Distance (meters) Wire Gauge (mm <sup>2</sup> )				
	14	12	10	8	6	2.0	3.0	5.0	8.0	13.0
2	210	336	540	861	1368	64	102	165	262	417
4	105	168	270	429	684	32	51	82	131	208
8	54	84	135	216	342	16	26	41	66	104
12	36	57	90	144	228	11	17	27	44	69
15	27	45	72	114	183	8	14	22	35	56

3% voltage drop, annealed copper wire at 20°C

**THIS PAGE IS  
LEFT BLANK  
INTENTIONALLY**

## Certifications

---



- ETL Certified to UL 1741 - Recognized Component
- CSA-C22.2 No. 107.1
- IEC 62109-1: 2010 Safety of Power Converters in PV Systems / JAS-ANZ Australian Certification and CEC Registered
- EN61000-6-2: 2005 - EMC Immunity, Industrial Environments
- EN55022: 1998 + A1 2000 + A2 2003 (Class B) EMC Emissions
- VCCI Radiated Emissions Limits for a Class B ITE
- ICES-003 Issue 4, Feb 2004 for a Class B Device
- FCC (Title 47 of CFR), Part 15 Subpart B Class B digital device

SunSaver MPPT™, MeterBus™ are trademarks of Morningstar Corporation

MODBUS™ and MODBUS TCP/IP™ are trademarks of Modbus IDA. [www.modbus-ida.org](http://www.modbus-ida.org)

© 2017 Morningstar Corporation. All rights reserved.

MS-001178 v3.5